

CS2-PM POTENTIOMETER Indicator

DESCRIPTION

CS2-PM Potentiometer Indicator has been designed with high accuracy measurement, display and communication of Ohm (3 wire) as like as Positioner.

☑ The meter supports Field Calibration function. It can be calibrated with sensor (Potentiometer) to meet machinery structure. They are also building in 4 Relay outputs, 3 External Control Inputs, 1 Analogue output and 1 RS485(Modbus RTU Mode) interface with versatile functions such as control, alarm, re-transmission and communication for a wide range of machinery and testing equipments applications.



FEATURE

- Measuring potentiometer signal **0~50Ω/~2.0KΩ; 0~2.0KΩ/~100.0KΩ** (3 wire)
- Field calibration with **potentiometer** to meet the system requirement
- 4 relay can be programmed individual to be a Hi / Lo / Hi Latch / Lo Latch / Go energized with Start Delay / Hysteresis / Energized & De-energized Delay functions, or to be a remote control.
- Analogue output and RS 485 communication port in option
- 3 external control inputs can be programmed individual to be Tare (Relative PV) / PV Hold / Maximum or Minimum Hold / DI (remote monitoring) / Reset for Relay Energized Latch....
- CE Approved & RoHS

APPLICATIONS

- Testing Equipments for thickness Measuring, Alarm, Control and Communication with PC/PLC
- Position control for Valve, Gate or various application

ORDERING INFORMATION

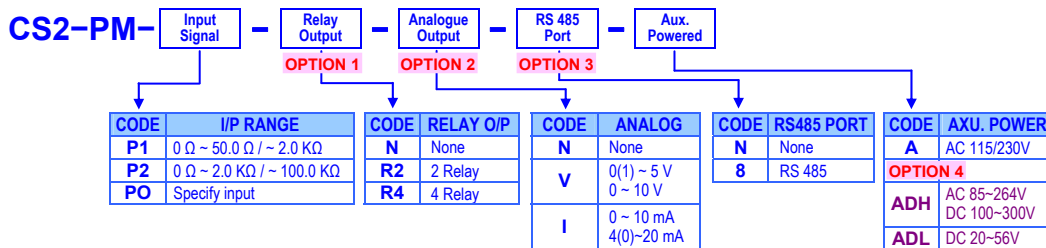

TECHNICAL SPECIFICATION

Input		
Measuring Range	Input Impedance	Excitation Voltage
0 Ω ~ 50 Ω / ~ 2.0 KΩ (3 wire)	≥ 1M ohm	About 0.2V
0 Ω ~ 2K Ω / ~ 100.0 KΩ (3 wire)		About 1.6V

Calibration: Digital calibration by front key

Field calibration: Calibration with sensor input high & low to meet system structure. And field calibration reset is not change the accuracy & linear of factory calibration.

A/D converter: 16 bits resolution

Accuracy: ± 0.04% of FS ± 1C;

Sampling rate: 15 cycles/sec

Response time: ≤ 100 m-sec.(when the AvG = "1") in standard

Input range: Input High and Low programmable
R.H.: Settable range: 0.00~100.00% of input range
R.L.: Settable range: 0.00~100.00% of input range

Display & Functions

LED: Numeric: 5 digits, 0.8"(20.0mm)H red high-brightness LED
 Relay output indication: 4 square red LED
 RS 485 communication: 1 square orange LED
 E.C.I. function indication: 3 square green LED
 Max/Mini Hold indication: 2 square orange LED

Display range: -19999~29999;

Scaling function: **L.S.C.:** Low Scale; Settable range: -19999~+29999
H.S.C.: High Scale; Settable range: -19999~+29999
 Programmable from 0 / 0.0 / 0.00 / 0.000 / 0.0000

Decimal point: **o.u.FL**, when input is over 20% of input range Hi
-o.u.FL, when input is under -20% of input range Lo

Over range indication: **o.u.FL**, when input is over 20% of input range Hi
Under range indication: **-o.u.FL**, when input is under -20% of input range Lo

Max / Mini recording: Maximum and Minimum value storage during power on.

Display functions: PV / Max(Mini) Hold / RS 485 Programmable

Front key functions: Up and down key can be set to be a function as ECI.

Low cut: Settable range: -19999~29999 counts

Digital fine adjust: **P.u.P.r.o.:** Settable range: -19999~+29999
P.u.S.P.n.: Settable range: -19999~+29999

Reading Stable Function

Average: Settable range: 1~99 times

Moving average: Settable range: 1(None)~10 times

Digital filter: Settable range: 0(None)/1~99 times

Control Functions(option)

Set-points: Four set-points

Control relay: Four relays
 Relay 2 & Relay 3: Dual FORM-C, 5A/230Vac, 10A/115V
 Relay 1 & Relay 4: Dual FORM-A, 1A/230Vac, 3A/115V

Relay energized mode: Energized levels compare with set-points:
 Hi / Lo / Go.12 / Go.23 / Hi.HLd / Lo.HLd; programmable
DO function: Energized by RS485 command of master.
 Start delay / Energized & De-energized delay / Hysteresis / Energized Latch

Energizing functions: **Start band**(Minimum level for Energizing): 0~9999counts
Start delay time: 0:00.0~9(Minutes):59.9(Second)
Energized delay time: 0:00.0~9(Minutes):59.9(Second)
De-energized delay time: 0:00.0~9(Minutes):59.9(Second)
Hysteresis: 0~5000 counts

External Control Inputs(ECI)

Input mode: 3 ECI points, Contact or open collect input, Level trigger
Functions: Relative PV (Tare) / PV Hold / Reset for Max or Mini. Hold / DI / Reset for Relay Energized latch
Debouncing time: Settable range 5 ~255 x (8m seconds)

Analogue output(option)

Accuracy: $\pm 0.1\%$ of F.S.; 16 bits DA converter
Ripple: $\leq \pm 0.1\%$ of F.S.
Response time: ≤ 100 m-sec. (10~90% of input)
Isolation: AC 2.0 KV between input and output
Output range: Specify either Voltage or Current output in ordering
Voltage: 0~5V / 0~10V / 1~5V programmable
Current: 0~10mA / 0~20mA / 4~20mA programmable
Voltage: 0~10V: $\geq 1000\Omega$;
Current: 4(0)~20mA: $\leq 600\Omega$ max
R_{oH}S (output range high): Settable range: -19999~29999
R_{oL}S (output range Low): Settable range: -19999~29999
R_{oL}H (output High Limit): 0.00~110.00% of output High
R_{oP}o: Settable range: -38011~+27524
R_{oS}Pn: Settable range: -38011~+27524

RS 485 Communication(option)

Protocol: Modbus RTU mode
Baud rate: 1200/2400/4800/9600/19200/38400 programmable
Data bits: 8 bits
Parity: Even, odd or none (with 1 or 2 stop bit) programmable
Address: 1 ~ 255 programmable
Remote display: to show the value from RS485 command of master
Distance: 1200M
Terminate resistor: 150 Ω at last unit.

Electrical Safety

Dielectric strength: AC 2.0 KV for 1 min, Between Power / Input / Output / Case
Insulation resistance: $\geq 100M$ ohm at 500Vdc, Between Power / Input / Output
Isolation: Between Power / Input / Relay / Analogue / RS485 / E.C.I.
EMC: EN 55011:2002; EN 61326:2003
Safety(LVD): EN 61010-1:2001

Environmental

Operating temp.: 0~60 °C
Operating humidity: 20~95 %RH, Non-condensing
Temp. coefficient: ≤ 100 PPM/°C
Storage temp.: -10~70 °C
Enclosure: Front panel: IEC 529 (IP52); Housing: IP20

Mechanical

Dimensions: 96mm(W) x 48mm(H) x 120mm(D)
Panel cutout: 92mm(W) x 44mm(H)
Case material: ABS fire-resistance (UL 94V-0)
Mounting: Panel flush mounting
Terminal block: Plastic NYLON 66 (UL 94V-0)
 10A 300Vac, M2.6, 1.3~2.0mm²(16~22AWG)
 550g / 350g(Aux. Power Code: ADH or ADL)

Power

Power supply: AC115/230V,50/60Hz;
Optional: AC 85~264V, DC 100~300V, DC 20~56V
Power consumption: 5.0VA maximum
Back up memory: By EEPROM

FRONT PANEL

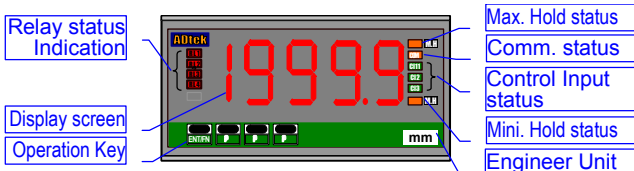

DIMENSIONS

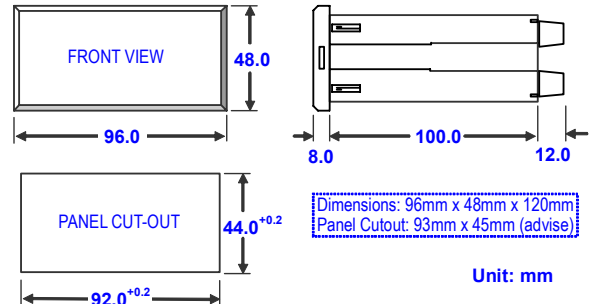

INSTALLATION

The meter should be installed in a location that does not exceed the maximum operating temperature and provides good air circulation.

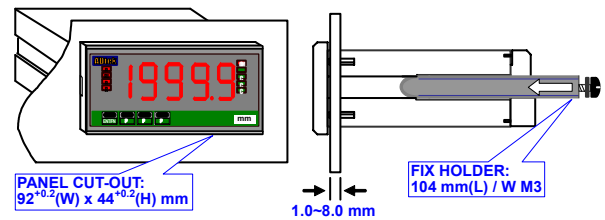

CONNECTION DIAGRAM

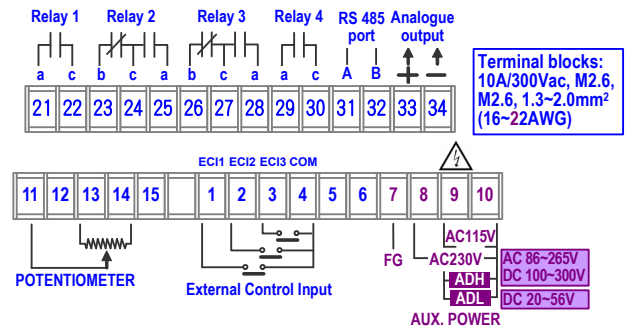

Please check the voltage of power supplied first, and then connect to the specified terminals. It is recommended that power supplied to the meter be protected by a fuse or circuit breaker.

Power Supply

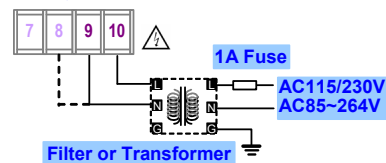

RS485 Communication Port

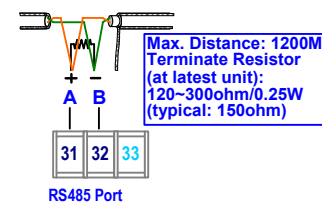

FUNCTION DESCRIPTION

Input & Scaling Functions

Input range: Analogue input High and Low programmable

The meter has to be specified and fixed according to ordering code (ex. 0~2.0kΩ (3 wires) in factory. If the meter has to install in difference range of input, the meter can be set in function [R.Lo] and [R.H] of input group to meet the input signal.

For example: The meter is 0~2.0kΩ (3 wires) input, and the signal from sensor is 0.5~1.5kΩ (3 wires). Please get into [INPUT GROUP] to set [R.H] (Analogue input High) to be 75.00% (2.0kΩ x 75.00% = 1.5kΩ), then the meter has been changed the input range to 0~1.5kΩ and the all relative parameters will work base on 0~1.5kΩ. The meter doesn't need re-calibration after change the [R.Lo] and [R.H].

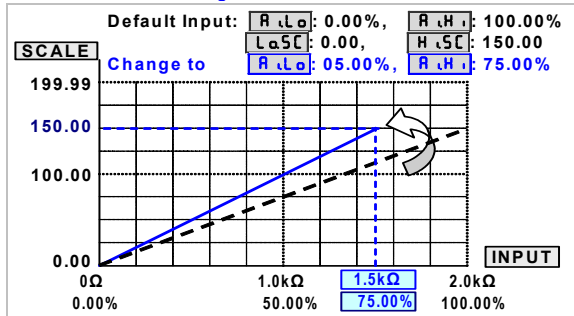

*The setting may cause display lower resolution. Please set lower resolution when the input signal has been high compressed.

Scaling function:

Setting the [LoSC] (Low scale) and [HiSC] (High scale) in [INPUT GROUP] to relative input signal. Reverse scaling will be done too. Please refer to the figure as below,

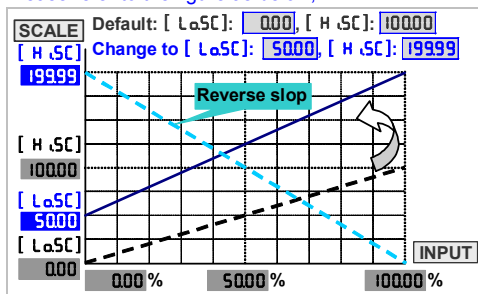

*Too narrow scale may cause display lower resolution.

Display & Functions

Max / Mini recording:

The meter will storage the maximum and minimum value in [user level] during power on in order to review drifting of PV. PV / Max(Mini) Hold / RS 485 programmable in [dSPL Y] function of [INPUT GROUP]

Display functions:

(Please refer to step A-07)

Present Value [PV]: The display will show the value that Relative to Input signal.

Maximum Hold [RH] / Minimum Hold [RH]:

The meter will keep display in maximum(minimum) value during power on, until manual reset by front key in [User level], rear terminal is close [External Control Input(ESI)] or press front down or up key to reset (according to setting, please refer to the function of the ECI Group)

▶ Please find the [M] sticker that enclosure the package of the meter to stick on the right side of square orange LED

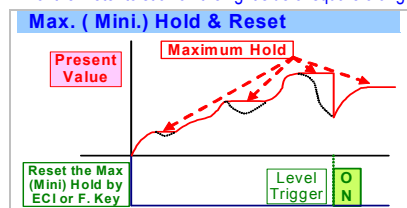

Remote Display by RS485 command [5485]:

The meter will show the value that received from RS485 sending. In past, The meter normally receive 4~20mA or 0~10V from AO or digital output from BCD module of PLC. We support a new solution that PV shows the value from RS485 command of master can so that can be **save cost and wiring** from PLC.

Other functions :

The meter is also support relative PV (Δ PV) and PV hold functions that set in [ECI GROUP]. Please refer to explain of ECI functions.

Low cut:

Settable range from -19999~+99999 counts. The users can set the value range.

1. If set the positive value (X1) here to display "0" which is expressed to be low-cut the PV between "+X1 (plus)" & "-X1(minus)" /absolute value

PV<| Setting value (X1) |, the display will be shown 0

EX: Low Cut is set for 0.50. If the display is from -0.50~+0.50, that will be 0.

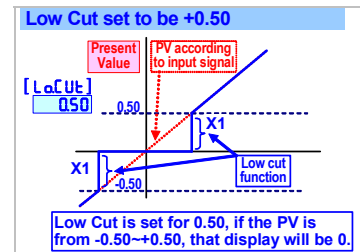

2. If set the negative value (X2) here to display "X2" which is expressed to be low-cut the PV that it's under the X2 setting value;

PV< Setting value(X2), the display will be shown X2.

EX: Low Cut is set for -0.01. If the display is < -0.01, and all the display will be -0.01.

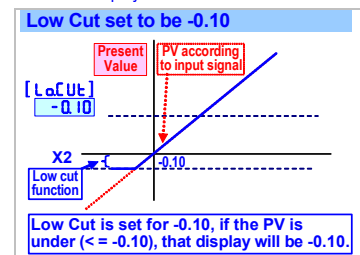

Digital fine adjust:

Settable range: -19999~+29999

Users can get Fine Adjustment for Zero & Span of PV by front key of the meter, and "Just Key In" the value which user want to show in the current input signals.

Especially, the [PwPro] & [PwSPn] are not only in zero & span of PV, but also any lower point for [PwPro] & higher point for [PwSPn]. The meter

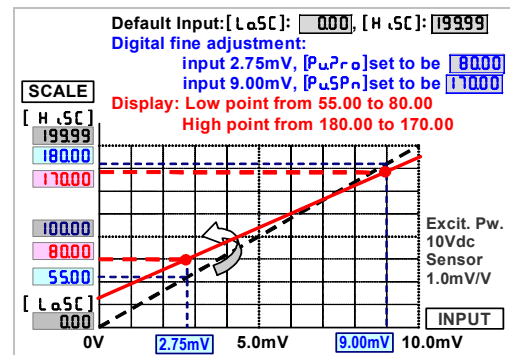

Reading Stable Function

Average display:

Jittery Display caused by the noise or unstable signal. User can set the times to average the readings, and to get smoothly display. The meter's sampling is 15cycle/sec. If the [**RLD**](Average) set to be **3** to express the display update with 5 times/sec. The meter will calculate the sampling 1-3 and update the display value. At meantime, the sampling 4-6 will be processed to calculate.

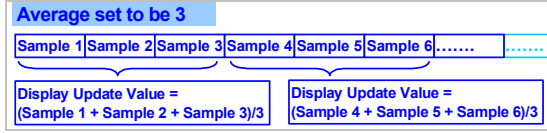

Remark: The higher average setting will cause the response time of Relay and Analogue output slower.

Moving average:

Jittery Display caused by the reasons as like as noise or unstable signal. User can set the times to average the readings, and get smoothly display. The meter's sampling is 15cycle/sec. If the [**RLM**](Moving Average) set to be **3** expressed the display update with 15 times/sec. In the first updated display value will be same as average function. In the next updated display value, the function will get the new fourth sample (sample 4) then throw away the first sample (sample 1) that the newest 3 samples(sample 2,3,4) will be calculated for the updated display value.

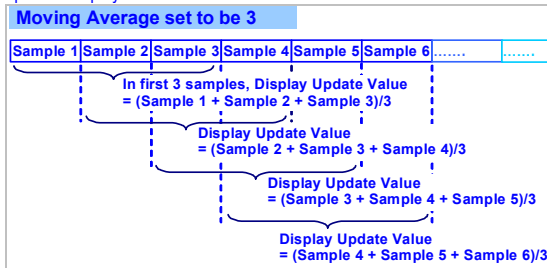

Remark: The higher moving average setting wouldn't cause the response time of Relay and Analogue output slower after first 3 samples.

Digital Filter:

The digital filter can reduce the magnetic noise in field.

The digital filter can reduce the influence of spark noise caused by magnetic of coil. If the values of samples are over digital filter band (fix in firmware and about 5% of stable reading) 3 times (Digital Filter set to be 3) continuously, the meter will admit the samples and update the new reading. Otherwise, it will be as treat as a noise and skip the samples.

Control Functions(option)

Relay energized mode: Hi / Lo-1.2 / Go-2.3 / Hi.HLd / Lo.HLd / DO programmable

Hi [**H**](Fig.1-①): Relay will energize when PV > Set-Point

Lo [**L**](Fig.1-②): Relay will energize when PV < Set-Point

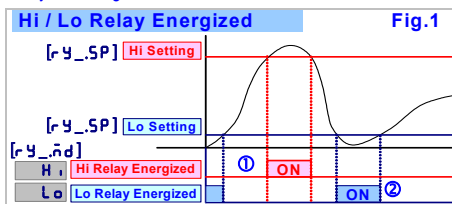

Go-1.2 [**Go-1.2]:** This function is programmable in Relay 4 only. If the Relay 4 set to be Go function, the relay will compare with [**r-y-SP**] and [**r-y2SP**].

Go relay energized when the condition is [**r-y-SP**] (Hi) > PV > [**r-y2SP**] (Lo)

Go-2.3 [**Go-2.3]:** This function is programmable in Relay 4 only. If the Relay 4 set to be Go function, the relay will compare with [**r-y2SP**] and [**r-y3SP**].

Go relay energized when the condition is [**r-y2SP**] (Hi) > PV > [**r-y3SP**] (Lo)

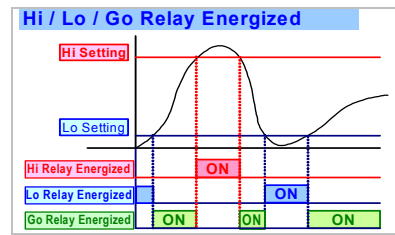

Hi.HLd [**H.HLd**] (Lo.HLd [**L.HLd**]):

The relay energized with latched function is for electrical safety and human protection.

For example, a current meter relay installed for the over current alarm of motor. Generally, over current of motor caused by over load, mechanical dead lock, aging of insulation and so on.

Above cases will alarm in the meter, if the user doesn't figure out the real reason and re-start the motor. It may damage the motor. The functions of Hi.HLd & Lo.HLd are designed must be manual reset the alarm after checking out and solving the issue. It's very important idea for electrical safety and human protection.

As the PV Higher (or lower) than set-point, the relay will be energized to latch except manual reset by from key in [**user level**] or [**EC**](ECI) set to be [**r-y-5t**] is closed.

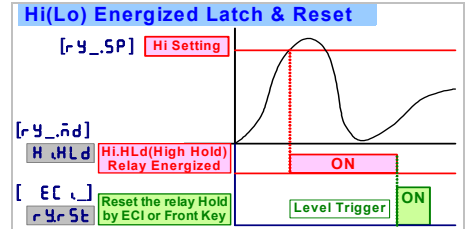

DO function [**do]:**

The function has been designed not only a meter but also an I/O interface. In the case of motor control cabinet can't get the remote function. It's very easily to get the ON/OFF status of switch from CS2 series with RS485 function. If the [**r-y-nd**] had been set [**do**], the relay will be energized by RS485 command directly, but no longer to compare with set-point.

Start delay band and Start delay time:

The functions have been designed for,
 ▶ To avoid starting current of inductive motor (6 times of rated current) with alarm.
 ▶ If the [**r-y-nd**] relay energized mode had been set to be [**Ld**](Lo) or [**L.HLd**](Lo & latch). As the meter is power on and no input to display the "0" caused the relay will be energized. User can set a band and delay time to inhibit the energized of relay.

Start band [**r-y5b](Fig.2-①):** Settable range from 0~9999 Counts

Start delay time [**r-y5d](Fig.2-②):** Settable range from 0.0(s)~9(m)59.9(s);

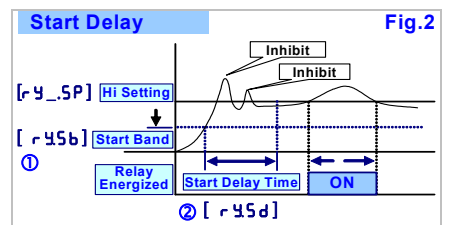

Hysteresis [**r-y-HY](Fig.3-①):** Settable range from 0~9999 Counts

As the display value is swing near by the set-point to cause the relay on and off frequently. The function is to avoid the relay on and off frequently such as compressor.....etc.,

Relay energized delay [**r-y-rd](Fig.3-②):** Settable range from 0.0(s)~9(m)59.9(s);

The function is to avoid the miss action caused by noise. Sometime, the display value will swing caused by spark of contactor...etc.. User can set a period to delay the relay energized.

Relay de-energized delay [r_y_f d] (Fig.3-9): Settable range from 0.0(s)~9(m)59.9(s);

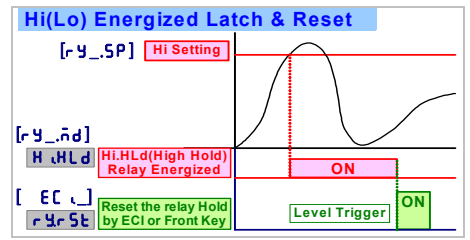
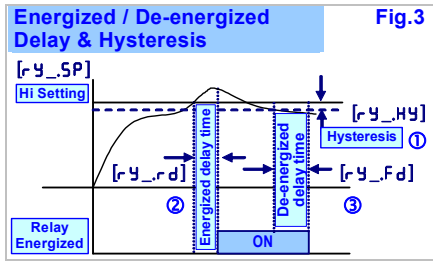

Debouncing time:

The function is for avoiding noise signal to into the meter. And The basic period is 8mseconds. It means you set the number that has to multiple 8 m-seconds.
For example: [dEbnc] set to be 5, it means 5 x 8mseconds = 40mseconds

External Control Inputs(ECI)

The three external control inputs are individually programmable to perform specific meter control or display functions. All E.C.I. have been designed in level trigger actions. Please pay attention, the ECI1 or ECI2 input will be disable while UP or Down Key has been set to be [yEs].

Functions:

Relative PV / PV Hold / Reset Max or Mini. Hold / DI / Reset for Relay Energized latch programmable.

Relative PV [rELP_u] or Tare:

The [EC_c] can be set to be [rELP_u] function. When the E.C.I. is closed, the reading will show the differential value.

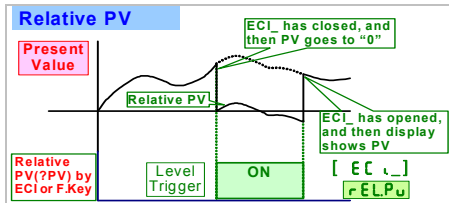

PV Hold [P_uHLd]:

The [EC_c] can be set to be [P_uHLd] (PV Hold) function. The display will be hold when the ECI is closed, until the ECI is to be open. Please refer to the below figures,

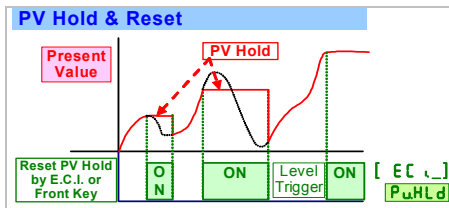

Reset for Maximum or Minimum Hold [r_rSt]:

When the [dSPly] function in [mPULt GrpUP] selected [r_rHLd] or [r_rHLd], the display will show Maximum or Minimum value.

The [EC_c] function can be set to be [r_rSt] function to reset the maximum and minimum value in [User Level] by terminals of ECI (close). Please refer to the figure as below.

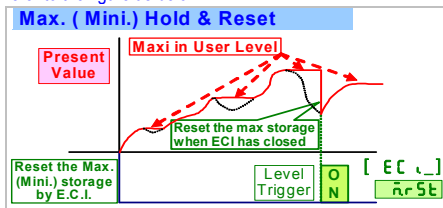

DI [d]:

The E.C.I can be set to be [d] function, when the meter building in RS485 port. It is easier to get remote monitoring a switch status through the meter as like as DI of PLC.

Reset for Relay Energized Latch [r_yrSt]:

If the relay energized mode has been set to be [H.HLd] (Energized latch), and the [EC_c] can be set to be [r_yrSt] (Reset the Relay energized latch). When the PV meets the condition of relay energizing, the relay will be energized and latch until the ECI is to be closed.

Analogue output(option)

Please specify the output type either an 0~10V or 4(0) ~ 20mA in ordering. The programmable output low and high scaling can be based on various display values. Reverse slope output is possible by reversing point positions.

Output range:

Voltage: 0~5V / 0~10V / 1~5V programmable
Current: 0~10mA / 0~20mA / 4~20mA programmable
Output High / Low scale, output limit, fine adjustment

Functions:

Output range high [RaHS]:
To setting the Display value High to versus output range High(as like as 20mA in 4~20)

Output range low [RaLS]:

To setting the Display value Low to versus output range Low(as like as 4mA in 4~20)

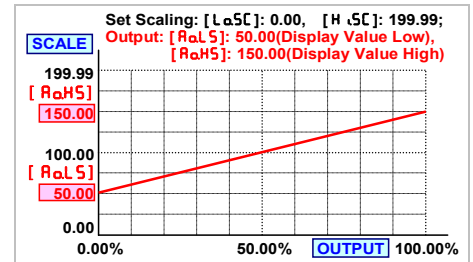

The range between [RaHS] and [RaLS] should be over 20% of span at least; otherwise, it will be got less resolution of analogue output.

Output High Limit [RaLnt]:

0.00~110.00% of output High User can set the high limit of output to avoid a damage of receiver or protection system.

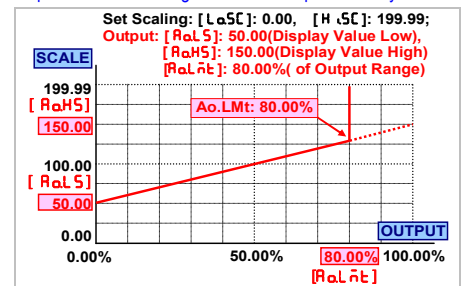

Fine zero & span adjustment:

Users can get Fine Adjustment of analogue output by front key of the meter. Please connect standard meter to the terminal of analogue output. To press the front key(up or down key) of meter to adjust and check the output.

Zero adjust [RaPzo]: Fine Zero Adjustment for Analog Output; Settable range: -38011~27524;

Span adjust [RaSPn]: Fine Span Adjustment for Analog Output; Settable range: -38011~27524;

RS 485 communication(option)

CS2 series supports Modbus RTU mode protocol to be used as Remote Terminal Unit (RTU) for monitoring and controlling in a SCADA (Supervisor Control And Data Acquisition) system. The baud rate can be up to 38400 bps. It's not only can be read the measured value and DI (external control inputs) status but also controls the relays output (DO) by RS485 communication ports.

CS2-PM & SC2-RL APPLICATION MEASURING & RS485 COMMUNICATION

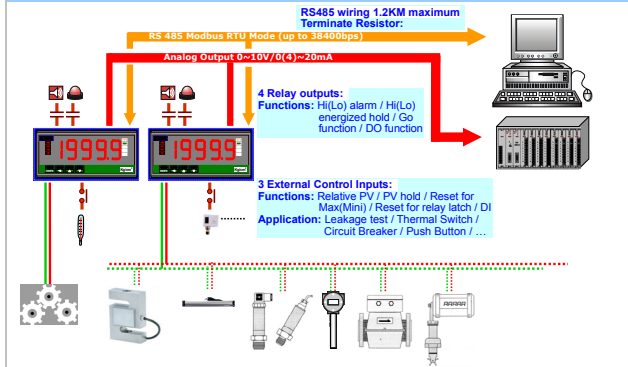

Field Calibration

In pass time, engineers have taken a lot of time to adjust meters or converter to meet the structure of machinery zero and span for the potentiometer measuring. Now, our CS2-PM support easier process to do it called "Field Calibration".

Please according to the numbers to do the field calibration (1 → 2 → 3 → 4 → 5 → 6)

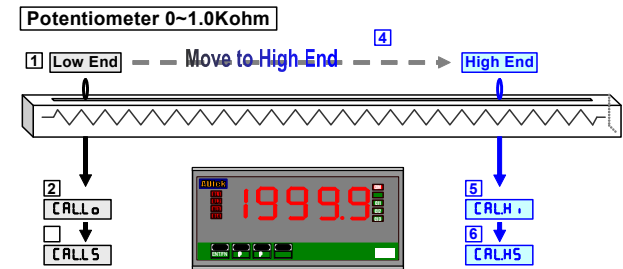

Remote Display:

The meter will show the value that received from RS485 command. In past, The meter normally receive 4~20mA or 0~10V from AO or digital output from BCD module of PLC. We support a new solution that PV shows the value from RS485 command of master so that can be save cost and wiring from PLC.

When the [d5PL9] set to be RS485, it means, the PV screen will show the number from RS485 command & data. The data (number) will be same as PV that will compare with set-point, analogue output and ECI functions so that is to control analogue output, relay energized and so on.

CS2 APPLICATION FOR REMOTE DISPLAY FROM RS485 COMMAND

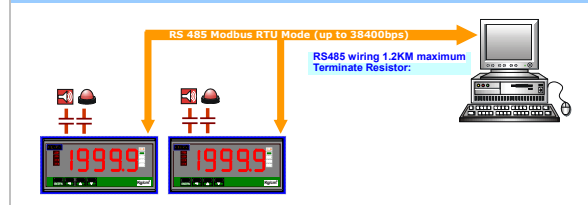

Calibration

System calibration by front key. The process of calibration, please refer to the operating manual

Optional Function

Customize function with quantities is welcome. Please contact with our sales for detail. The appendix code of optional function will be added behind the code of auxiliary power as like as xxx-A-HSM.

ERROR MESSAGE

BEFORE POWER ON, PLEASE CHECK THE SPECIFICATION AND CONNECTION AGAIN.

SELF-DIAGNOSIS AND ERROR CODE:

DISPLAY	DESCRIPTION	REMARK
ouFL	Display is positive-overflow (Signal is over display range)	(Please check the input signal)
-ouFL	Display is negative-overflow (Signal is under display range)	(Please check the input signal)
ouFL	ADC is positive-overflow (Signal is higher than input range high 20%)	(Please check the input signal)
-ouFL	ADC is negative-overflow (Signal is lower than input range low -20%)	(Please check the input signal)
EEP ↔ FAiL	EEPROM occurs error	(Please send back to manufactory for repaired)
AiCnG ↔ Pu	Calibrating Input Signal do not process	(Please process Calibrating Input Signal)
AiC ↔ FAiL	Calibrating Input Signal error	(Please check Calibrating Input Signal)
AoCnG ↔ Pu	Calibrating Output Signal do not process	(Please process Calibrating Output Signal)
AoC ↔ FAiL	Calibrating Output Signal error	(Please check Calibrating Output Signal)

FRONT PANEL:

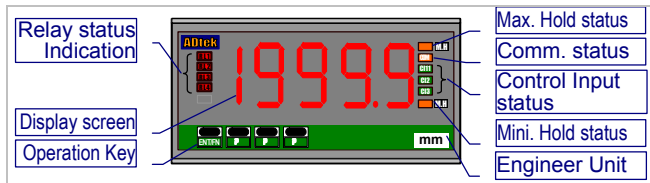

Numeric Screens

0.8"(20.0mm) red high-brightness LED for 4 2/3 digital present value.

I/O Status Indication

- **Relay Energized:** 4 square red LED
 - RL1** display when Relay 1 energized;
 - RL2** display when Relay 2 energized;
 - RL3** display when Relay 3 energized;
 - RL4** display when Relay 4 energized;
- **External Control Input Energized:** 3 square green LED
 - EC1** display when E.C.I. 1 close(dry contact)
 - EC2** display when E.C.I. 2 close(dry contact)
 - EC3** display when E.C.I. 3 close(dry contact)
- **RS485 Communication:** 1 square orange LED
 - COM** will flash when the meter is receive or send data, and **COM** flash quickly means the data transient quicker.
- **Max/Mini Hold indication:** 2 square orange LEDs
 - M.H** displayed: When the display function has been selected in Maximum or Minimum Hold function.
- **Stickers:**
Each meter has a sticker what are functions and engineer label enclosure.
- **Relay energized mode:** **HH HI LO LL DO**
- **E.C.I. functions mode:**
 - PV.H** PV.H(PV Hold) / **Tare** Tare / **DI** DI(Digital Input)
 - M.RS** M.RS(Maximum or Minimum Reset) /
 - R.RS** R.RS(Reset for Relay Latch)
- **Engineer Label:** over 80 types.

- **Operating Key:** 4 keys for **Enter(Function)** / **Shift(Escape)** / **Up key** / **Down key**

	Setting Status	Function Index
Up key	Increase number	Go back to previous function index
Down key	Decrease number	Go to next function index
Shift key	Shift the setting position	Go back to this function index, and abort the setting
Enter/Fun key	Setting Confirmed and save to EEPROM	From the function index to get into setting status

- **Pass Word P.CodE:** Settable range: 0000~9999;
User has to key in the right pass word so that get into [Programming Level] . Otherwise, the meter will go back to measuring page. If user forgets the password, please contact with the service window.
- **Function Lock:** There are 4 levels programmable.
 - **None [nonE]:** no lock all.
 - **User Level [USer]:** User Level lock. User can get into User Level for checking but setting.
 - **Programming Level [EnG]:** Programming level lock.
User can get into programming level for checking but setting.
 - **ALL [RLl]:** All lock. User can get into all level for checking but setting.
- **Front Key Function**
 - The **Key** can be set to be the same function as the setting of EC11. Ex. The EC11 set to be **PuHLd** and the function **[E.1=UP]** set to be **YES** in **[EC + GroUP]**. When user presses **Key**, the PV will hold as like as EC11 close.
 - The **Key** can be set to be the same function as the setting of EC12. Ex. The EC12 set to be **ELPu** and the function **[E.2=dn]** set to be **YES** in **[EC + GroUP]**. When user presses **Key**, the PV will show relative value as like as EC12 close.
 - ▶ **If the front key function has been set, the terminal input for EC1 will be disabling.**

OPERATING DIAGRAM (The detail description of operation, please refer to operating manual.)

User Level

Press for 1 sec. can back to Measuring

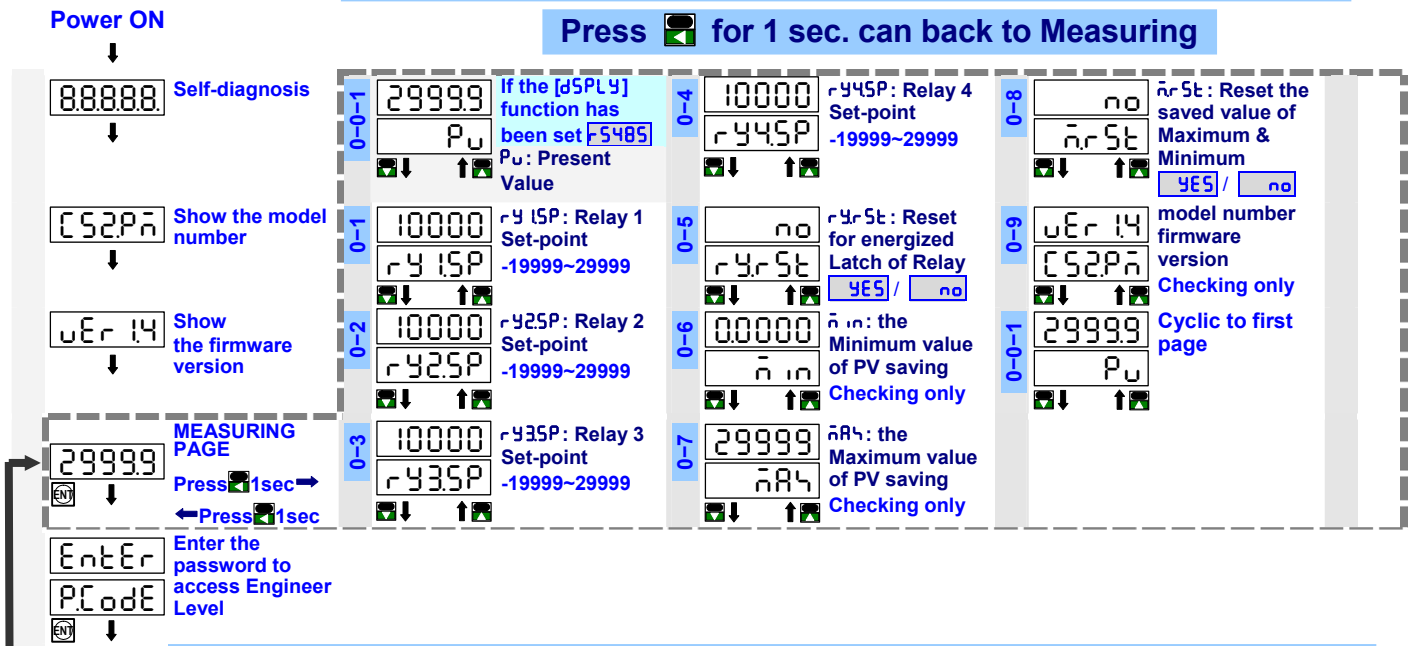

Programming Level

Press for 1 sec. can back to Measuring

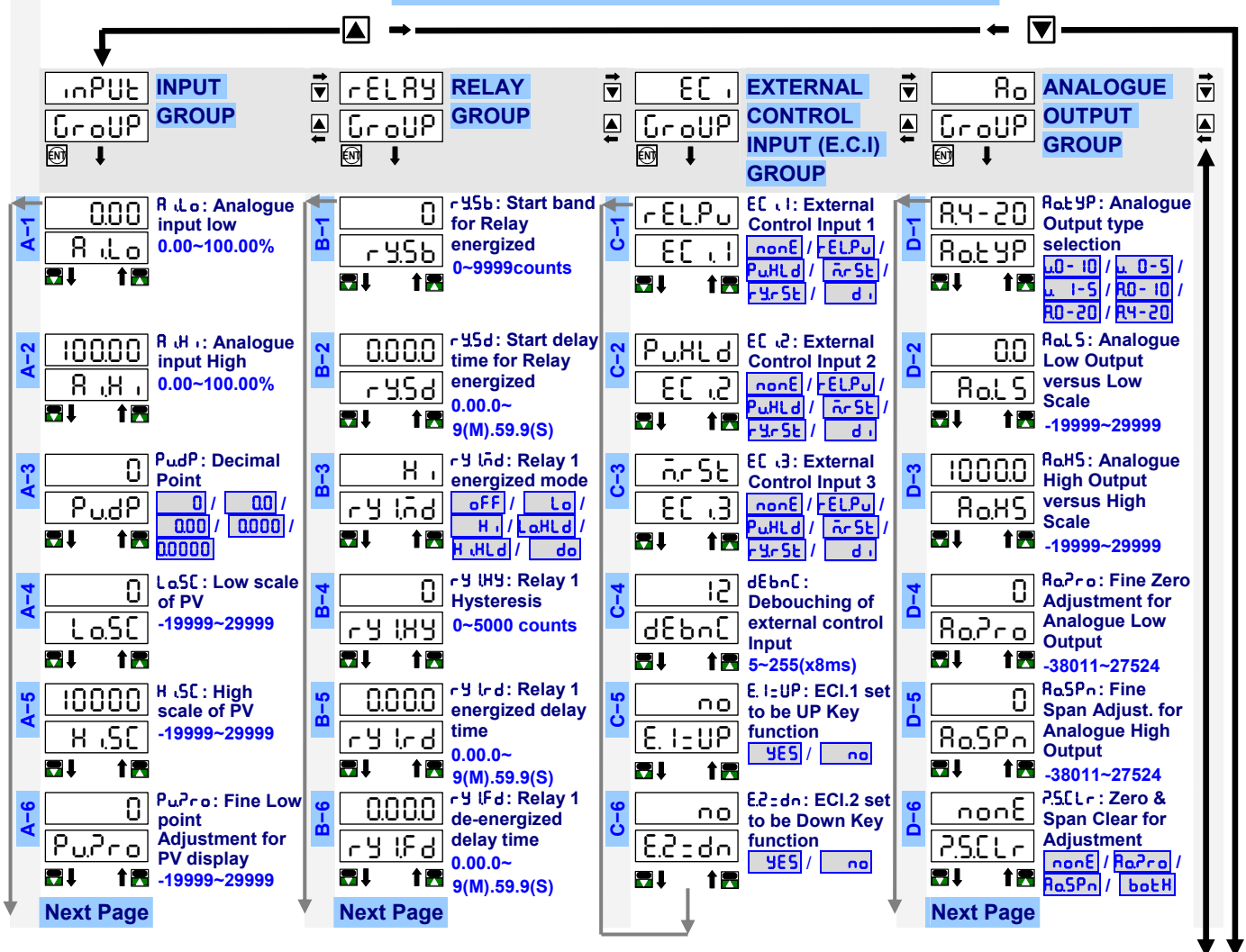

CS2-PM

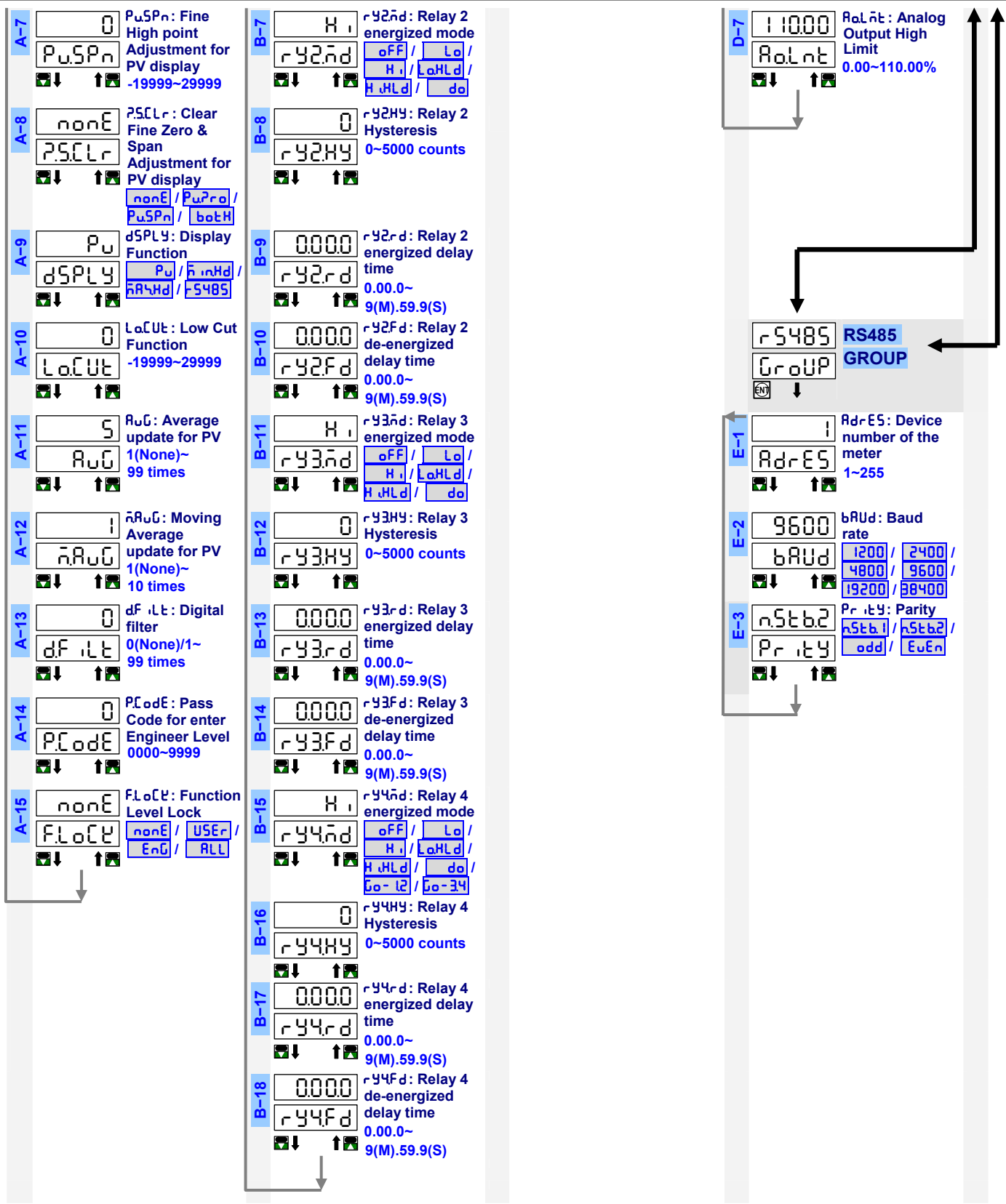

▶ Please refer to operating manual for detail description

FIELD CALIBRATION

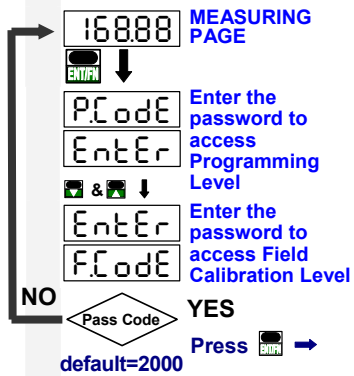

- Once the user select field calibration, the [LoSC](step A-2) and [HiSC](A-3) will be instead of [CALLS] and [CALHS], and can not to be change. If user has to change the scaling, it's the only way to access field calibration level to set in [CALLS](step F-2) and [CALHS](step F-4).

- Please double check the [LoSC](step A-2) and [HiSC](A-3) are correct after selection the dEFLd or F.iELd

F-1	<p>CALLo Field Calibration Low</p> <p>Adjust the structure to be a lower signal output status (or any lower status) and keep it in stable.</p> <p>▶ Press [ENTR] to read signal of the lower status. ▶ Press [ENTR] again to finish the calibration lower point, and go to next page.</p>
F-2	<p>CALLS Field Calibration Lower point</p> <p>CALLS: the value to be set is relative to Field Calibration lower point</p> <p>▶ Press [ENTR] to set the value of lower scale</p>
F-3	<p>CALHi Field Calibration High</p> <p>Adjust the structure to be a higher signal output status (or any higher status) and keep it in stable.</p> <p>▶ Press [ENTR] to read signal of the higher status ▶ Press [ENTR] again to finish the calibration higher point, and go to next page.</p>
F-4	<p>CALHS Field Calibration Higher point</p> <p>CALHS: the value to be set is relative to Field Calibration higher point</p> <p>▶ Press [ENTR] to set the value of Higher scale</p>
F-5	<p>CSEL Calibration parameter selection</p> <p>▶ Press [ENTR] to access the function and stand by selection</p> <p>▶ Press [ENTR] or [ENTR] to select (default: dEFLd); Settable: <u>dEFLd</u> / <u>F.iELd</u> <u>dEFLd</u> (default calibration) <u>F.iELd</u> (Field calibration)</p>